

DESIGNING WITH ENGINEERING

PLASTICS

with survey tables

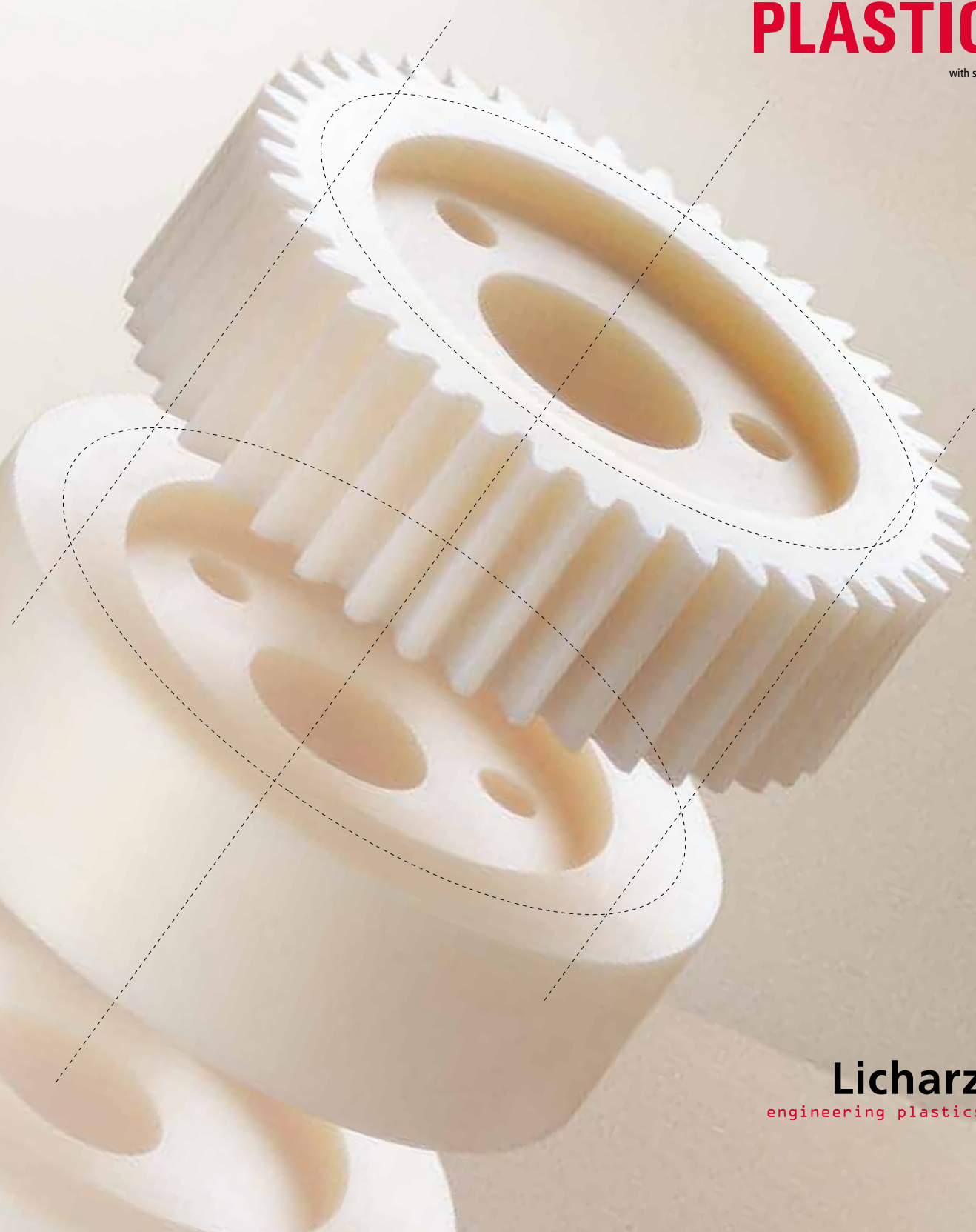



LICHARZ
PLASTIC GEARS

The competitive edge through engineered components made of plastic

1. Use of plastics as a gear material

Although thermoplastic gears are unsuitable for applications in high performance gears and for transmitting high power, they have opened up a broad field of application. The specific material properties allow use under conditions where even high quality metallic materials fail. For instance, plastic gears must be used if the following are the key requirements:

- Maintenance-free
- High wear resistance when used in a dry running application
- Low noise
- Vibration damping
- Corrosion resistance
- Low mass moment of inertia due to low weight
- Inexpensive production

For a plastic to be able to satisfy these requirements, it is absolutely vital that the right material is chosen and that the design is carried out in a material-related manner.

1.1 Materials

Only a few thermoplastics are significant for the manufacture of gears. The plastics are described in detail in the previous chapters, so here we will only describe them in regard to gear teeth.

- **PA 6** Universal gear material for machine engineering; it is wear resistant and impact absorbing even when used in rough conditions, less suitable for small gears with high dimensional requirements.
- **PA 66** Is more wear resistant than PA 6 apart from when it is used with very smooth mating components, more dimensionally stable than PA 6 as it absorbs less moisture, also less suitable for small gears with high dimensional requirements.
- **LiNOTAM** (PA 6 C) Essentially like PA 6 and PA 66, however, it is especially wear resistant due to its high degree of crystallinity.
- **LiNOTAM^{HIPERFORMANCE 612}/LiNOTAM^{DRIVE 612 Fe}** (PA 6/12 G) Tough modified polyamide, suitable for use in areas with impact-like load peaks, wear resistance comparable to **LiNOTAM**.
- **LiNOTAM^{HIPERFORMANCE 1200}/LiNOTAM^{DRIVE 1200 Fe}** (PA 12 G) Tough-hard polyamide with relatively low water absorption, hence, better dimensional stability than other polyamides, especially suitable for use in areas with impact-like load peaks, excellent wear resistance.
- **LiNOTAM^{GLIDE}** (PA 6 C + Oil) Self-lubricating properties due to oil in the plastic, hence, excellent for dry running applications and especially wear resistant.
- **LiNOTAM^{GLIDE PRO T}** (PA 6 C + solid lubricant) Self-lubricating properties due to solid lubricants contained in the plastic, therefore suitable for dry running and is wear resistant.
- **POM-C** Because of its low moisture absorption it is especially suitable for small gears with high dimensional stability demands, not so loadable in dry running applications due to its hardness, however, if permanently lubricated, POM-C gears are more loadable than polyamide ones.

Plastic gears

- **PE-UHMW** Because of its low stability, it can only be used for gears that are not subjected to high loads, good damping properties and chemical resistance, hence mainly suitable for use in applications with mechanical vibration and in chemically aggressive environments.

1.2 Counterparts

Hardened steel is the most suitable counterpart regarding wear and utilisation of the load carrying capacity, as it ensures very good dissipation of friction heat. In regard to surface properties, the same applies as with friction bearings: the harder the steel the less wear on the wheel and pinions. As a guiding value, we recommend a maximum roughness depth of $R_t = 8$ to $10 \mu\text{m}$ both in lubricated operation and in dry running applications. For gears that are not subject to heavy loads, it is possible to mate plastic/plastic. The surface roughness is insignificant for wear. When choosing a material, it should be remembered that the driving pinions are always subjected to a higher level of wear. Consequently, the more wear resistant material should always be chosen for the pinions (→ pinion: steel, wheel: plastic or pinion: PA, wheel: POM).

1.3 Lubrication

The statements made in the chapter on »Friction bearings« regarding dry running and the use of lubricants also apply here. Basically it should be noted that installation lubrication considerably improves the service life and the running-in behaviour. Materials that are modified with a lubricant, such as **LINNOTAM GLIDE**, have much longer service lives than all other plastics, even without lubrication. Continuous lubrication with oil leads to better heat dissipation and consequently to a longer life and higher levels of transmitted power. When the component is lubricated with grease, the circumferential speed should not exceed 5 m/sec, as otherwise there is a danger that the grease will be cast off. Due to polyamide's tendency to absorb moisture, water lubrication is not recommended for polyamide components.

1.4 Noise development

Plastics in general have good damping properties. This considerably reduces noise on plastic gears compared to metal ones. The diagram opposite shows the sound intensity curves of gear mates steel/steel (a) and steel/plastic (b). It shows maximum differences of 9 dB. Hence, steel/steel is up to three times as loud as steel/plastic.

1.5 Manufacture

Plastic gears are manufactured with the same machining process as metal gears. As the cutting forces are very low, the profile can be manufactured in one cycle with high feed rates, which in turn reduces manufacturing costs.

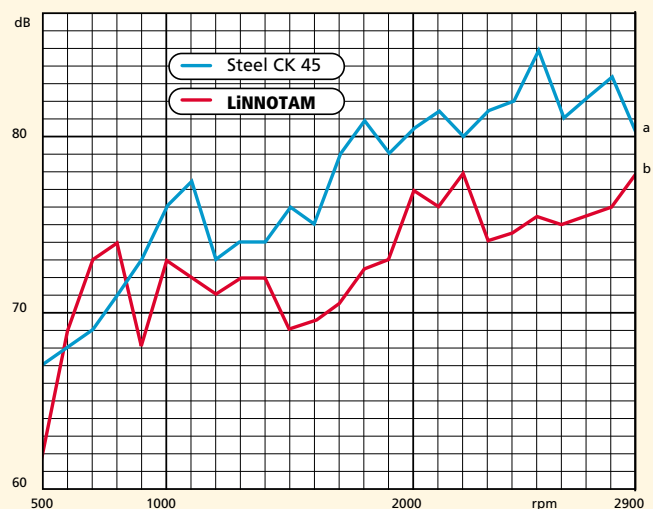

When manufacturing with high feed rates, corrugated surfaces can be produced. At first these give an unfavourable impression. However, in dry running applications the faces of the teeth are quickly smoothed after a short running-in period. In lubricated applications, the corrugated form acts as a lubrication pocket where the lubricant can collect – to the advantage of the gear.

In other words, this corrugation does not display any reduction in quality.

Basically when machining plastic gears, depending on the module, qualities of 9 to 10 can be achieved. Regarding the tooth quality that can be achieved, it should be noted that the rolling tooth flanks of plastic gears easily fit one another. Therefore, greater tolerances are allowed than would be the case with metal gears. This especially applies to power transmitting pinions. For the grade that is exclusively related to tangential composite error F_i'' and tangential tooth-to-tooth error f_i'' this means that up to two grades more are permitted than for similar gears made from metal. The tooth play is increased by one to two grades compared to steel to compensate for temperature and moisture effects.

2. Design information

The following design information is intended to assist when dimensioning new gear components. Existing data should be used for gear designs that are in use and which have been tried and tested.

2.1 Width of the tooth face

For plastic gears there is basically no problem in extending their width to the same size as the diameter. Determining the smallest width is dependent upon the axial stability of the gear. No test results are available in regard to the connection between the life of the component and the width of the tooth face or regarding a determination of the optimum width of tooth face. Practical experience has, however, shown that the width of the tooth face should be at least six to eight times the module.

For the mating components steel/plastic it is better to design the plastic gear slightly smaller than the steel pinion to make sure that the plastic gear is loaded across the entire width of the tooth face. A similar situation arises with the mating components plastic/plastic, where the dimensions of the gear on which the higher wear is expected should be slightly narrower. This prevents wear on the edges of the teeth, which could affect the running behaviour.

2.2 Module, angle of pressure and number of teeth

The load bearing capacity of plastic gears can be directly affected by the choice of module and angle of pressure. If, while maintaining the same peripheral force, the module/angle of pressure is increased, the root-strength of the teeth increases. However, compared to steel gears, the actual increase is less, as the effective contact ratio factor decreases and it is no longer possible for several teeth to engage simultaneously. A higher contact ratio factor, however, can be better for the load bearing capacity than increasing the root-strength of an individual tooth. We can derive the following connection from this (applies mainly to slow running or impact loaded gears):

- Preferably a small module for tough elastic thermoplastics (increase in the contact ratio factor, → several teeth engaged simultaneously).
- Preferably a large module for hard thermoplastics (increase in the root-strength of the teeth, as a higher contact ratio factor is not possible due to the inferior deformation behaviour).

In the case of gears with a high peripheral speed, attention must be paid that the movement is not affected by the effective contact ratio factor.

Plastic gears

The angle of pressure for involute teeth is defined at 20°. Nevertheless, it can occasionally be necessary to change the angle of pressure (e.g. to decrease the number of teeth or reduce running noise). Angles of pressure < 20° lead to thinner and hence less loadable teeth with steep tooth profiles but low running noise. Angles of pressure > 20° produce sharper, thicker teeth with a greater root strength and flatter profiles.

In regard to the number of teeth, it should be noted for higher peripheral speeds that the ratio between the number of teeth may not be an integer multiple. If this is the case, the same teeth always engage, which encourages wear.

2.3 Helical gearing

Experience has shown that helical plastic gears run quieter with a small helix angle than spur toothed types. However, the expected increase in the load bearing ability is smaller than is the case with steel gears. Although the length of the face contact line increases and the load is distributed among several teeth, the load is uneven and the teeth are deformed. This negates the advantage of helical gearing to a certain degree. As with metal gears, helical toothed plastic gears are calculated via a spur toothed spare wheel. $\beta \approx 10^\circ\text{-}20^\circ$.

2.4 Profile correction

Profile corrections are generally necessary when

- a gear pair has to be adapted to suit a specified axle base (positive or negative profile correction)
- the number of teeth is not reached and this causes undercut (positive profile correction)

In the application, attention should be paid that in the case of negative profile correction the undercut is not too great. This would result in greatly minimised root strength of the teeth, which could reduce the life and load bearing capacity of the gear.

Vice versa, in the case of positive profile correction, the thicker tooth root could cause a loss in the deformation capability and a subsequent reduction in the contact ratio factor.

2.5 Flank clearance and crest clearance

Because of the high thermal expansion factors of plastics when dimensioning gears, attention must be paid to the material-related fitting of the flank and crest clearances so that a minimum flank clearance is guaranteed. When plastic gears are used, it has proven practical to maintain a minimum flank clearance of $\approx 0.04 \cdot \text{modulus}$. The built-in flank clearance is thus

$$S_e = S_{e0} + 2 \cdot l \cdot \sin \alpha (k\alpha + k_f) \quad [\text{mm}]$$

where

S_{e0} = minimum flank clearance in mm

l = total distance consisting of plastic between the two rotational axes in mm

α = angle of pressure

$k\alpha$ = coefficient of elongation

k_f = correction factor for moisture absorption (to be used for polyamides, can be found in the chapter on »Friction bearings«)

For the inbuilt crest clearance, a measure of $0.3 \cdot \text{module}$ has proven to be practical. This takes account of temperature fluctuations of up to $\pm 20 \text{ }^\circ\text{C}$ and also makes adequate consideration for any inaccuracies in the toothed gears.

2.6 Power transmission

The feather key and groove type of connection that is generally used in machine engineering is also used for plastic gears. For a connection such as this, the flank of the key groove must be examined to ensure that it does not exceed the permissible surface pressure. The surface pressure is

$$p_f = \frac{M_d \cdot 10^3}{i \cdot r_m \cdot h \cdot b} \quad [\text{MPa}]$$

where

M_d = transmitted torque in Nm

i = number of groove flanks

r_m = radius from the centre of the shaft to the centre of the bearing flank in mm

h = height of the bearing flank in mm

b = width of the bearing flank in mm

The value produced from the calculation is compared with Diagram 1 and may not exceed the maximum permissible values. However, it should be noted that this value contains no safety factor for shock-type loads or safety reserves. Depending on the load, we recommend a safety factor of 1.5 to 4.

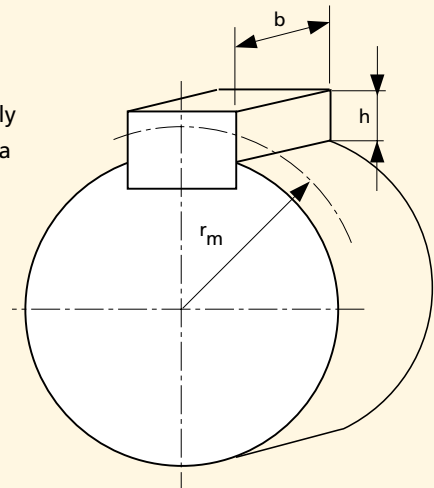
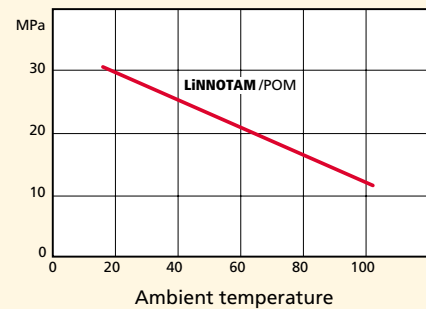

Diagram 1: Guiding value for permissible surface pressure



Because of the notch sensitivity of plastics when key grooves are being manufactured, attention should be paid that the edges are designed with a radius. However, this is generally not possible because the usual cutting tools and feather keys are sharp edged. When larger torque is being transmitted this can also cause deformation in the hub.

If the calculation of the flank pressure should produce high pressure values that are not permissible, or if hub deformation is feared, there are several possibilities of power transmission available. One possibility is the non-positive connection of the wheel body with a steel insert. This is screwed to the wheel body. The diagram opposite shows one possible design solution.

For fixing the steel insert we recommend hexagon socket screws according to DIN 912, property class 8.8 or better in the following dimensions.

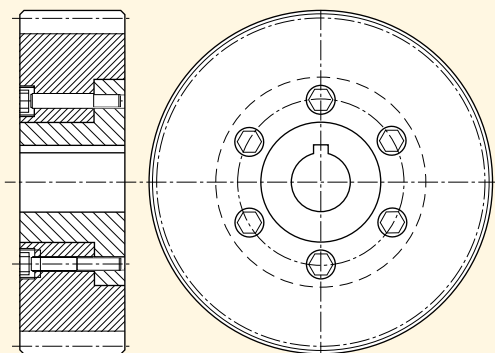

Tip diameter	Number of screws	Screw size
up to 100 mm	3	M6
up to 200 mm	4	M 8
above 200 mm	6	M8/M 10

Plastic gears

For gears with relatively thin walls, it is advisable to use hexagon socket screws with a low head according to DIN 6912, property class 8.8 or better.

One alternative to the use of a screwed steel fitting is to design the gears in **LINNOTAMDRIVE 612** or **LINNOTAMDRIVE 1200 Fe**. The metallic core which is connected to the plastic both in a form-fit and non-positive manner enables the shaft-hub connection to be calculated and dimensioned like a metallic component as usual. The form-fit and non-positive connection between the plastic casing and the metallic core is created with a knurl.

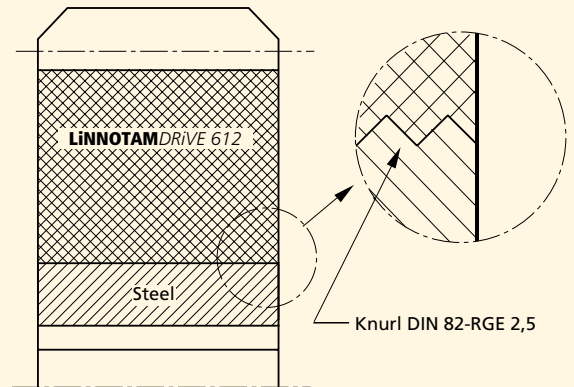

3. Calculating thermoplastic gears

The reasons for the premature breakdown of thermoplastic gears are generally the same damage aspects and principles that occur in metallic gears. This is why the calculation of plastic gears does not differ in principle from the known methods. The only difference is that the material-specific properties of plastics are included in the calculations in the form of correction factors.

3.1 Torque M_d , peripheral force F_u and peripheral speed v

The torque is:

$$M_d = 9.550 \cdot \frac{P}{n} \quad [\text{Nm}]$$

where

P = power in kW

n = speed in min^{-1}

The peripheral force is:

$$F_u = 2 \cdot 10^3 \cdot \frac{M_d}{d_0} \quad [\text{N}]$$

where

M_d = torque in Nm

d_0 = reference diameter
in mm

The peripheral speed

is calculated as:

$$v = \frac{d_0 \cdot \pi \cdot n}{60 \cdot 10^3} \quad [\text{m/s}]$$

where

d_0 = reference diameter

n = speed in min^{-1}

3.2 Tooth body temperature ϑ_z and tooth flank temperature ϑ_f in continuous operation

As with all designs made from thermoplastic materials, temperature also plays a major role for gears in regard to the load bearing capacity of the component. A distinction is made between the tooth body temperature ϑ_z and the tooth flank temperature ϑ_f .

The tooth body temperature is responsible for the permissible tooth root loading and tooth deformation, whereas the tooth flank temperature is used to roughly estimate the level of wear. However, it is very difficult to determine these two temperatures accurately because on a rotating gear the heat transmission coefficient can only be estimated roughly. Consequently, any arithmetical determination of the temperatures is liable to have a certain amount of error. In particular, when the tooth flank temperature is being calculated, quite often high values are produced which, in some cases, are even above the melting temperatures of the plastics. However, in practice no melting of the tooth profile has been observed. Nevertheless, the values can be regarded as characteristic and comparison temperature values. It can be assumed that the excessive calculated values would in any case guarantee a design which is on the safe side.

For the thermal calculation of the gears, the friction heat, the heat dissipated from the gear in the gear room and the heat that is dissipated from the gear room to the outside must be considered. Under these conditions, the following:

$$\vartheta_{1,2} = \vartheta_U + P \cdot \mu \cdot 136 \cdot \frac{i + 1}{z_{1,2} + 5i} \cdot \left(\frac{k_2 \cdot 17100}{b \cdot z_{1,2} \cdot (v \cdot m)^{\frac{3}{4}}} + 7,33 \cdot \frac{k_3}{A} \right) \text{ [}^\circ\text{C]}$$

where

Index 1 for the pinion

Index 2 for the wheel

ϑ_U = ambient temperature in $^\circ\text{C}$

P = power in kW

μ = coefficient of friction

z = teeth

i = transmission ratio z_1/z_2 with

z_1 = number of teeth in pinion

b = width of the tooth face in mm

v = peripheral speed in m/sec

m = module in mm

A = surface of the gear casing in m^2

k_2 = material-related factor

k_3 = gear-related factor in $\text{m}^2 \text{K/W}$

For factor k_2 the following must be included depending on the temperature to be calculated:

Calculation of flank temperature:

$k_2 = 7$ for mating components steel/plastic

$k_2 = 10$ for mating components plastic/plastic

$k_2 = 0$ in the case of oil lubrication

$k_2 = 0$ at ≤ 1 m/sec

Calculation of root temperature:

$k_2 = 1.0$ for mating components steel/plastic

$k_2 = 2.4$ for mating components plastic/plastic

$k_2 = 0$ in the case of oil lubrication

$k_2 = 0$ at ≤ 1 m/sec

For factor k_3 and the coefficient of friction μ , the following must be included independent of the temperature to be calculated:

$k_3 = 0$ for completely open gear $\text{m}^2 \text{K/W}$

$k_3 = 0.043$ to 0.129 for partially open gear in $\text{m}^2 \text{K/W}$

$k_3 = 0.172$ for closed gear in $\text{m}^2 \text{K/W}$

$\mu = 0.04$ for gears with permanent lubrication

$\mu = 0.07$ for gears with oil mist lubrication

$\mu = 0.09$ for gears with assembly lubrication

$\mu = 0.2$ PA/steel

$\mu = 0.4$ PA/PA

$\mu = 0.25$ PA/POM

$\mu = 0.18$ POM/steel

$\mu = 0.2$ POM/POM

3.2.1 Tooth body temperature ϑ_2 and tooth flank temperature ϑ_f in intermittent operation

Analogous to friction bearings, because of the lower amount of heat caused by friction, gears in intermittent operation are increasingly loadable the lower the duty cycle. The relative duty cycle ED is considered in the equation in section 3.2 by introducing a correction factor f.

The relative duty cycle is defined as the ratio between the load duration t and the overall cycle time T as a percentage.

$$ED = \frac{t}{T} \cdot 100 \text{ [%]}$$

where

t = total of all load times within the cycle time T in min

T = cycle time in min

Plastic gears

For thermoplastic gears, the overall cycle time is defined as $T = 75$ min. The total of all individual load times occurring within this 75 min forms the load duration t .

With the value that has been calculated in this manner it is now possible to determine the correction factor f from Diagram 2. Attention should be paid that each load duration which exceeds 75 min (regardless of whether this is only once) is evaluated as a continuous load.

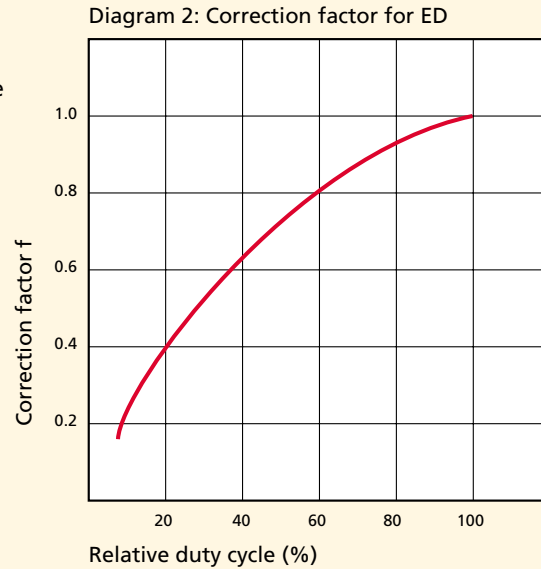

Taking account of the correction factor, the tooth flank temperature and tooth body temperature is

$$\vartheta_{1,2} = \vartheta_U + P \cdot f \cdot \mu \cdot 136 \cdot \frac{i + 1}{z_{1,2} + 5i} \cdot \left(\frac{k_2 \cdot 17.100}{b \cdot z_{1,2} \cdot (v \cdot m)^{\frac{3}{4}}} + 7,33 \cdot \frac{k_3}{A} \right) \text{ [}^\circ\text{C]}$$

The values given in section 3.2 can be used for the factors k_2 , k_3 and the coefficient of friction μ .

3.3 Calculating the root strength of teeth

If the tooth root load σ_F exceeds the permissible load σ_{Fper} under loading, it must be assumed that the teeth will break. For this reason the tooth root load must be calculated and compared with the permissible values. If the pinion and gear are constructed from plastic, the calculations must be carried out separately for each of them.

The tooth load is:

$$\sigma_F = \frac{F_U}{b \cdot m} \cdot K_B \cdot Y_F \cdot Y_\beta \cdot Y_\epsilon \text{ [MPa]}$$

where

F_U = peripheral force in N

b = gear width in mm (where the width of the pinion and gear differ: use the smaller width + m as a calculation value for the wider gear)

m = module in mm

K_B = operating factor for different types of drive operation, from Table 2

Y_F = tooth shape factor from Diagram 3

Y_β = helix factor to take account of the increase in load bearing capacity in helical gearing, as this is the case with plastic gears, this value is to be set as 1.0

Y_ϵ = contact ratio factor from Table 1, where $Y_\epsilon = 1/\epsilon_\alpha$ and $\epsilon_\alpha = \epsilon_{\alpha z1} + \epsilon_{\alpha z2}$

Table 1: Partial transverse contact ratio for gears without profile correction

z	14	15	16	17	18	19	20	21	22	23	24
$\epsilon_{\alpha z}$	0.731	0.740	0.749	0.757	0.765	0.771	0.778	0.784	0.790	0.796	0.801
z	25	26	27	28	29	30	31	32	33	34	35
$\epsilon_{\alpha z}$	0.805	0.810	0.815	0.819	0.822	0.827	0.830	0.833	0.837	0.840	0.843
z	36	37	38	39	40	41	42	43	44	45	46
$\epsilon_{\alpha z}$	0.846	0.849	0.851	0.854	0.857	0.859	0.861	0.863	0.866	0.868	0.870
z	47	48	49	50	51	52	53	54	55	56	57
$\epsilon_{\alpha z}$	0.872	0.873	0.875	0.877	0.879	0.880	0.882	0.883	0.885	0.887	0.888
z	58	59	60	61	62	63	64	65	66	67	68
$\epsilon_{\alpha z}$	0.889	0.891	0.892	0.893	0.895	0.896	0.897	0.989	0.899	0.900	0.901
z	69	70	71	72	73	74	75	76	77	78	79
$\epsilon_{\alpha z}$	0.903	0.903	0.904	0.906	0.906	0.907	0.909	0.909	0.910	0.911	0.912
z	80	81	82	83	84	85	86	87	88	89	90
$\epsilon_{\alpha z}$	0.913	0.913	0.914	0.915	0.916	0.917	0.917	0.918	0.919	0.919	0.920
z	91	92	93	94	95	96	97	98	99	100	101
$\epsilon_{\alpha z}$	0.920	0.921	0.922	0.922	0.923	0.924	0.924	0.925	0.925	0.926	0.927

Table 2: Operating factor K_b

Mode of operation of the driving machine	Mode of operation of the driven machine			
	Even	Moderate impact	Average impact	Strong impact
Even	1.0	1.25	1.5	1.75
Moderate impact	1.1	1.35	1.6	1.85
Average impact	1.25	1.5	1.75	2.0
Strong impact	1.5	1.75	2.0	2.25

Diagram 3: Tooth formation factor Y_F as a function of the number of teeth

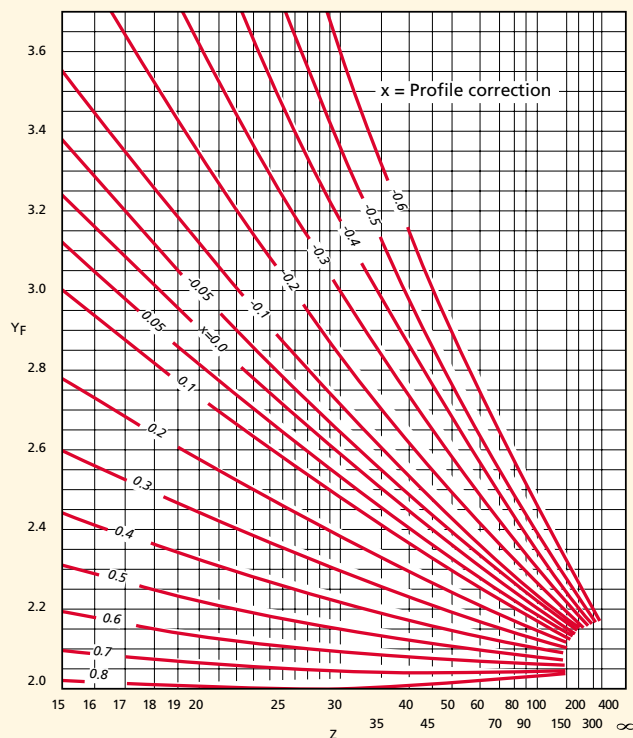

Plastic gears

In the case of profile corrected toothed gears the factor Y_ϵ must be adjusted accordingly.

The following applies:

$$\epsilon_\alpha = \frac{z_1}{2 \cdot \pi} \cdot (\tan \alpha_{E1} - \tan \alpha_{A1}) \quad \text{and}$$

$$\tan \alpha_{A1} = \tan \alpha_{tw} \cdot \left(1 + \frac{z_2}{z_1} \right) - \frac{z_2}{z_1} \tan \alpha_{A2}$$

The value $\tan \alpha_{E1}$ is dependent on the correction value:

$$D_1 = \frac{d_{K1}}{d_{G2}}$$

where

d_{K1} = outside diameter of pinion
 d_{G2} = base diameter of large wheel

The value $\tan \alpha_{A2}$ is dependent on the correction value:

$$D_2 = \frac{d_{K2}}{d_{G1}}$$

where

d_{K2} = outside diameter of large wheel
 d_{G1} = base diameter of pinion

The values for $\tan \alpha_{E1}$ and $\tan \alpha_{A2}$ can be taken from Diagram 5. The effective pressure angles α_{tw} and $\tan \alpha_{tw}$ are calculated from the profile correction $x_{1,2}$ and the number of teeth $z_{1,2}$ where Index 1 stands for the pinion and Index 2 for the large gear. The effective pressure angles for spur gears are shown in Diagram 4.

Diagram 4: Effective pressure angle α_{tw} , $\tan \alpha_{tw}$

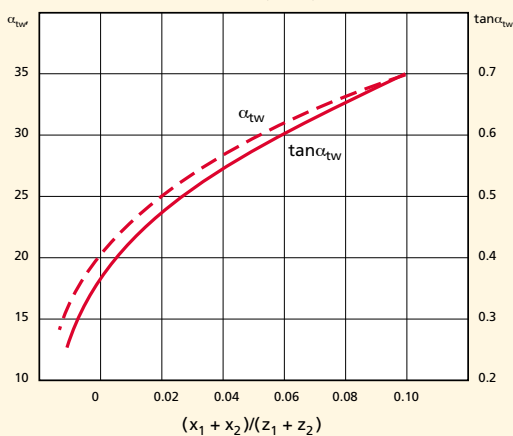
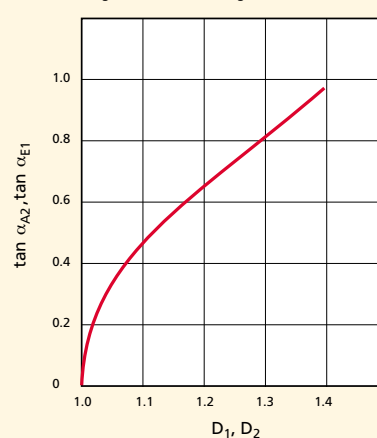

Diagram 5: Correction diagram for transverse contact ratio



3.4 Calculating tooth profile strength

Excessive pressure on the tooth profile can cause pitting or excessive wear. The wear is particularly obvious in the root and crest of the tooth, which changes the tooth formation and consequently leads to uneven transmission of motion. In order to prevent premature failure due to excessive wear or pitting, the tooth flank pressure σ_H must be determined. The pressure occurring on the tooth flank is:

$$\sigma_H = \sqrt{\frac{F_U \cdot (z_1 + z_2)}{b \cdot d_0 \cdot z_2}} \cdot K_B \cdot Z_\epsilon \cdot Z_H \cdot Z_M \quad [\text{MPa}]$$

where

F_U = peripheral force in N
 z_1 = number of teeth in pinion
 z_2 = number of teeth in large gear
 b = gear width in mm (where the width of the pinion and gear differ: use the smaller width + m as a calculation value for the wider gear)

d_0 = reference diameter in mm
 K_B = operating factor for different types of drive operation, from Table 2
 Z_ϵ = contact ratio factor
 Z_H = zone factor
 Z_M = material factor

The contact ratio of several teeth acts like a widening of the tooth. This apparent widening is taken account of with the contact ratio factor Z_ϵ and equated for spur and helical gears. The contact ratio factor becomes:

$$Z_\epsilon = \sqrt{\frac{4 - (\epsilon_{\alpha z1} + \epsilon_{\alpha z2})}{3}}$$

where

$\epsilon_{\alpha z1}$ = partial transverse contact ratio of pinion from Table 1

$\epsilon_{\alpha z2}$ = partial transverse contact ratio of large wheel from Table 1

The tooth formation factor Z_H takes account of the tooth flank distortion. In the case of non-profile corrected spur teeth with an angle of pressure of $\alpha = 20^\circ$ the zone factor can be approximated with $Z_H = 1.76$. For profile corrected spur teeth Z_H can be taken from the diagram opposite. For angles of pressure other than 20° the following applies:

$$Z_H = \frac{1}{\cos \alpha} \cdot \sqrt{\frac{1}{\tan \alpha_{tw}}}$$

where

α = normal angle of pressure

$\tan \alpha_{tw}$ = effective pressure angle from Diagram 4

The elasticity of the plastic and consequently the effective contact surface of the tooth profile are considered with the material factor Z_M . It can be said with sufficient accuracy that:

$$Z_M = \sqrt{0,38 \cdot E'} \quad \text{und} \quad E' = \frac{E_1 \cdot E_2}{E_1 + E_2}$$

where

E_1 = dynamic modulus of elasticity of the pinion

E_2 = dynamic modulus of elasticity of the gear

The different moduli of different materials for the pinion and gear have been taken into account. For the mating components plastic/steel the corresponding factor for Z_M can be taken from Diagram 8. For the mating components of gears made from the same plastic the following applies:

$$Z_{M(K/K)} = \frac{1}{\sqrt{2}} \cdot Z_{M(K/St)}$$

If the gear and pinion are made from different plastics, the factor Z_M (K/St) for the softer plastic should be used. The tooth flank temperature is determined with the help of the formula in sections 3.2 or 3.2.1.

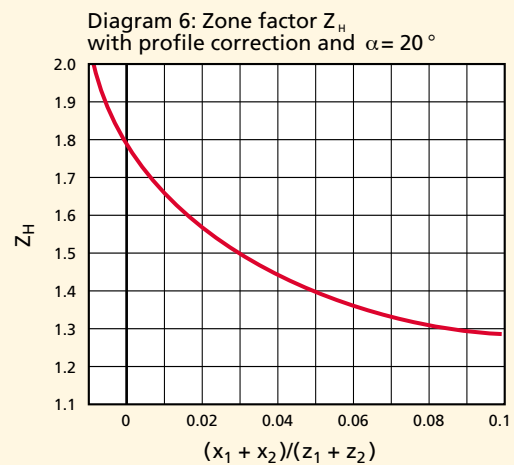

Plastic gears

Diagram 7: Dynamic modulus of elasticity

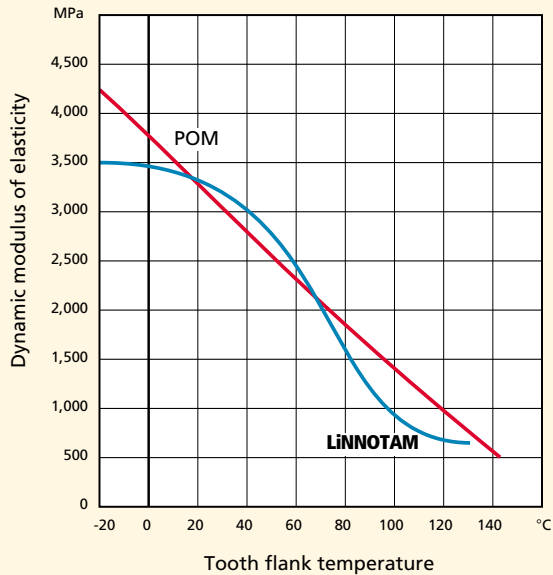
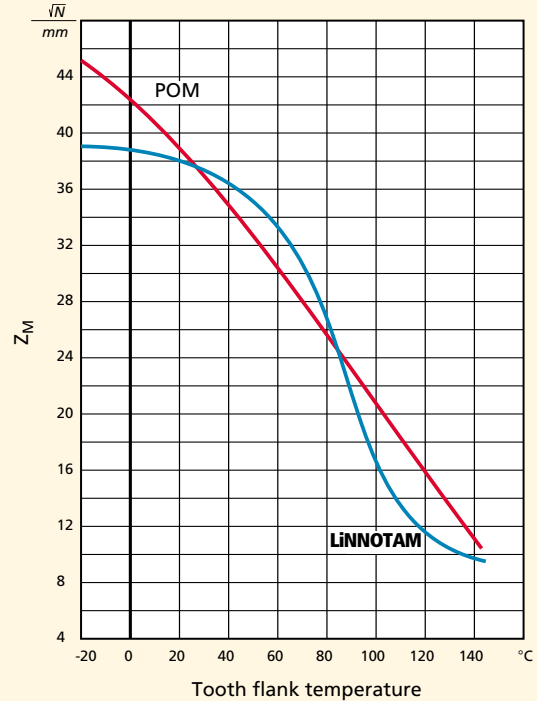

Diagram 8: Material factor for mating components K/St.



3.5 Safety factor S

The results for σ_F and σ_H from the calculations must be compared with the permissible values.

As a rule a minimum safety factor of 1.2 to 2 is advisable. The following applies:

$$\sigma_{Fzul} = \frac{\sigma_{Fmax}}{S} \quad \text{and} \quad \sigma_{Hzul} = \frac{\sigma_{Hmax}}{S}$$

where

S = advisable safety factor

σ_{Fmax} = permissible tooth root load from Diagrams 9 and 10 in combination with the tooth temperature

or

S = advisable safety factor

σ_{Hmax} = permissible flank pressure from Diagrams 11 to 14 in combination with the tooth temperature

The following table contains several minimum safety factors in relation to operating conditions.

Type of operation	Minimum safety factor
Normal operation	1.2
High load reversal	1.4
Continuous operation with load reversals $\geq 10^8$	≥ 2

The permissible tooth root loads and flank pressures are shown in the following diagrams.

Diagram 9: Root strength of teeth σ_{Fmax} for POM

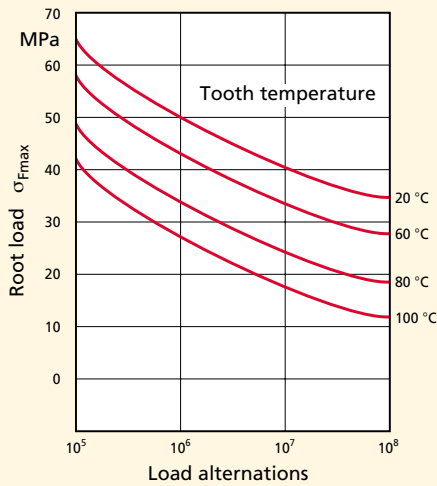

Diagram 10: Root strength of teeth σ_{Fmax} for LINNOTAM

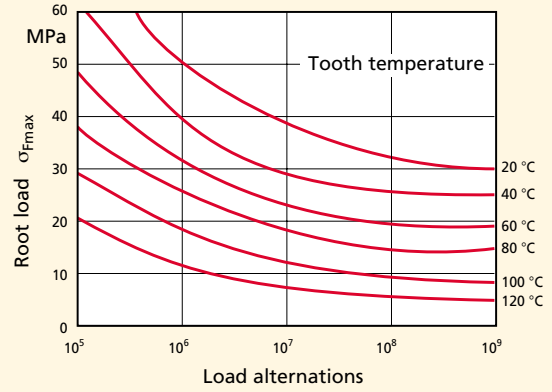

Diagram 11: Contact surface pressure σ_{Hmax} , LINNOTAM, dry running

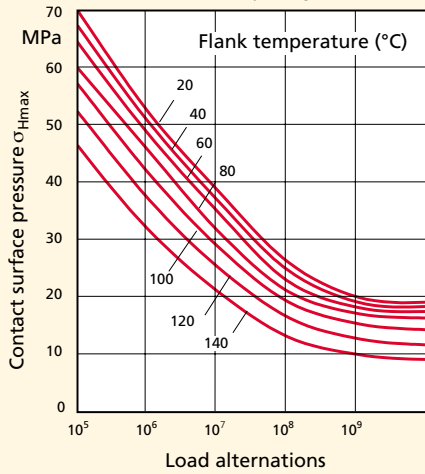

Diagram 12: Contact surface pressure σ_{Hmax} , LINNOTAM, grease lubrication

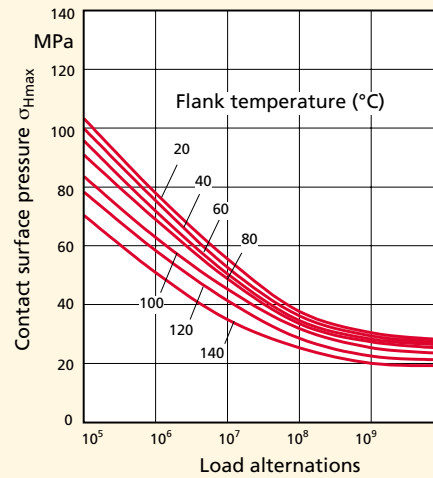

Diagram 13: Contact surface pressure σ_{Hmax} , LINNOTAM, oil lubrication

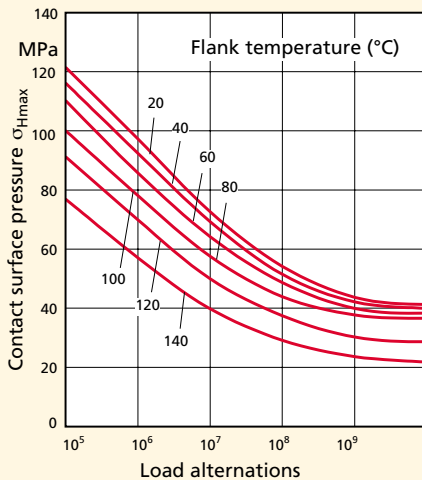
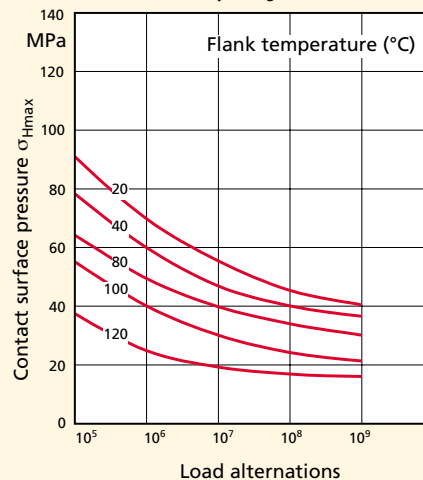

Diagram 14: Contact surface pressure σ_{Hmax} , POM, dry running



Plastic gears

3.6 Calculating tooth distortion

The tooth distortion that occurs when a load is applied acts like a pitch error during the transition from the loaded to the unloaded condition of the tooth. As excessive deformation could cause the gear to break down, plastic gears must be examined in regards to their compliance with the maximum permissible tooth distortion.

Tooth distortion f_k as a correction of the crest of the tooth in the peripheral direction becomes:

$$f_k = \frac{3 \cdot F_u}{2 \cdot b \cdot \cos \alpha_0} \cdot \varphi \cdot \left(\frac{\psi_1}{E_1} + \frac{\psi_2}{E_2} \right) \quad [\text{mm}]$$

where

φF = correction value from Diagram 15

$\psi_{1,2}$ = correction values from Diagram 16

$E_{1,2}$ = modulus of elasticity from Diagram 7

For the mating components plastic/steel the following applies:

$$\frac{\psi_{ST}}{E_{ST}} = 0$$

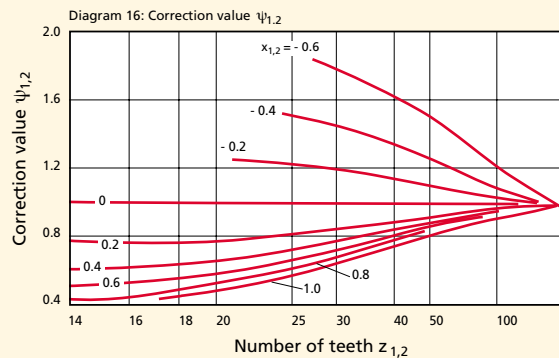
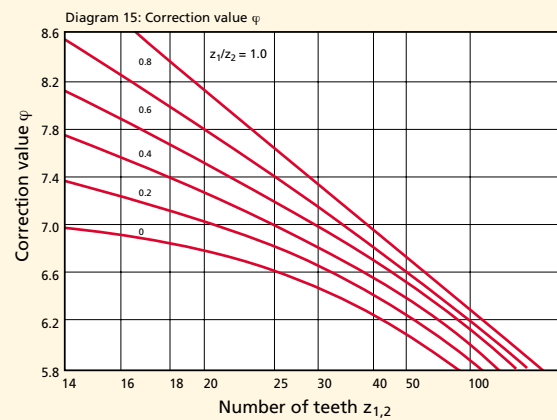

The permissible tooth distortion is generally determined by the requirements that are placed on the gears in regard to running noise and life. Practice has shown that the running noises increase considerably from a tooth distortion $f_k = 0.4$ mm. Another parameter is the ratio between tooth distortion and module.

In the form of an equation, the permissible limiting values become:

$$f_{kzul} \leq 0.4 \quad [\text{mm}]$$

bzw.

$$f_{kzul} \leq 0.1 \cdot m \quad [\text{mm}]$$

The calculated values should not exceed the limiting values. If, however, this is the case one would have to accept increased running noises and a shorter life.

Germany: Licharz GmbH
Industriepark Nord | D-53567 Buchholz | Germany
Telefon: +49 (0) 2683 - 977 0 | Fax: +49 (0) 2683 - 977 111
Internet: www.licharz.com | E-Mail: info@licharz.com

France: Licharz eurl.
Z.I. de Leveau – Entrée G | F-38200 Vienne | France
Téléphone: +33 (0) 4 74 31 87 08 | Fax: +33 (0) 4 74 31 87 07
Internet: www.licharz.fr | E-Mail: info@licharz.fr

Great Britain: Licharz Ltd
34 Lanchester Way | Royal Oak Industrial Estate | Daventry, NN11 8PH | Great Britain
Phone: +44 (0) 1327 877 500 | Fax: +44 (0) 1327 877 333
Internet: www.licharz.co.uk | E-Mail: sales@licharz.co.uk

USA: Timco Inc
2 Greentown Rd | Buchanan NY 10511 | USA
Phone: +1 914 - 736 0206 | Fax: +1 914 - 736 0395
Internet: www.timco-eng.com | E-Mail: sales@timco-eng.com

LICHARZ

EXACTLY YOUR SOLUTION:

We think with you from the beginning!

We offer advice on how to utilise plastics and develop your component together with you:

- we check application conditions on your machine
- we check your design drawing
- we recommend the material and the process
- we manufacture a prototype for you if required

You will receive your product quickly and economically, exactly as you need it!



nominal charge 18.00 Euro